



metalarteTM
icons

En

Lewit Kvadrat

Jordi Veciana

When **Lewit** first appeared in the **Metalarte** catalogue no one doubted that it would soon become one of the icons of the brand. It is designed by the refined and minimalist hand of **Jordi Veciana**, who has worked in the industrial and interior design world for years on both sides of the Atlantic, for Polo Ralph Lauren and some brands of the Grupo Inditex. It was his first serially produced design in the lighting field and was created with the intention of it never going out of fashion. “A lamp inspired by a pure rationalist vision, is composed of two simple geometric forms. The base consists of an upright rectangular parallelepiped formed by thin metallic rods which support a cylindrical screen-diffuser. This clean conjunction of recognizable forms makes for easy positioning and carrying. The aesthetic purity of the Lewit’s forms is destined to endure and withstand changing fashions.” Time has proved him right and he has earned the right to buy himself a brand new suit made with an elegant **Kvadrat** fabric. The classic black and white shades of this collection are now complemented by three subtle colours for those with more Scandinavian tastes.

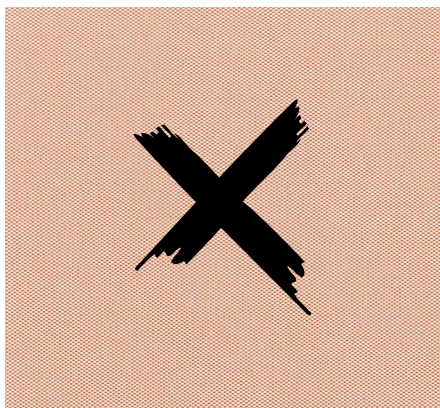

kvadrat 518



kvadrat 748

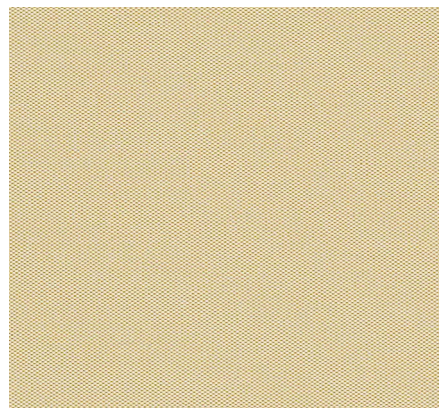

kvadrat 418

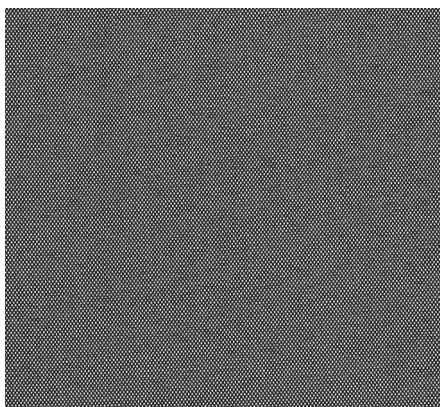

kvadrat 167



kvadrat 248

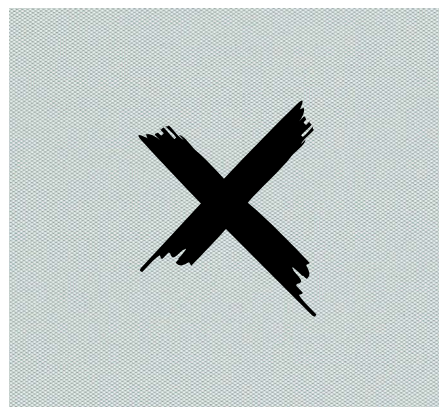

kvadrat 738

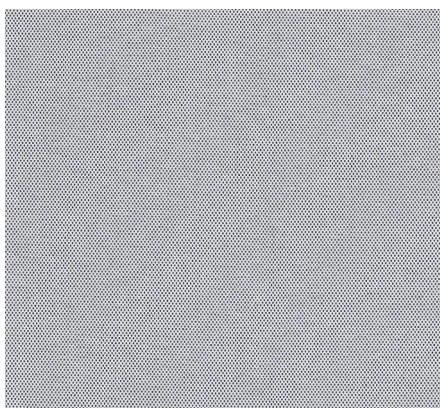

kvadrat 127

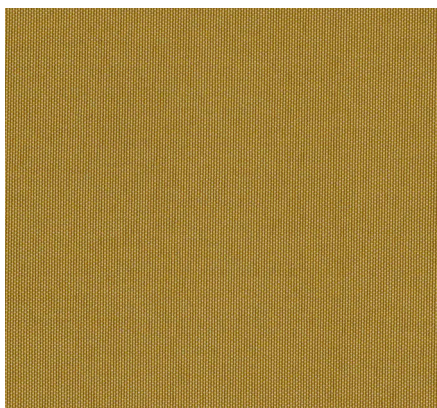

kvadrat 448

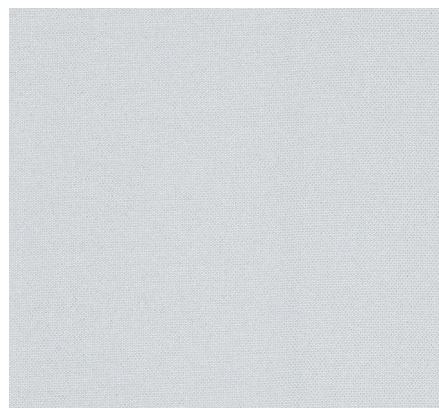

kvadrat 117



kvadrat 228

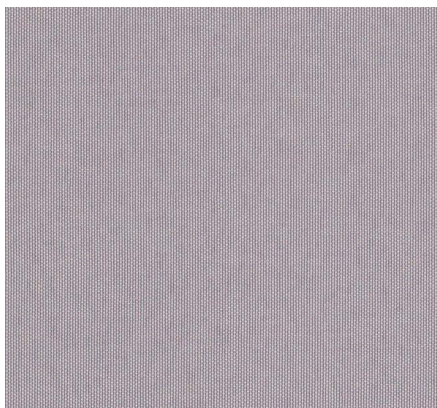

kvadrat 638

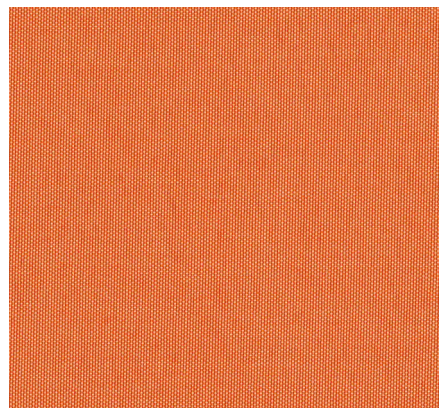

kvadrat 548

**Lewit
Colours**



Green 738



Coral 518



Grey 228

Kvadrat Colours



Black



White

Standard Colours



**Lewit
Family**

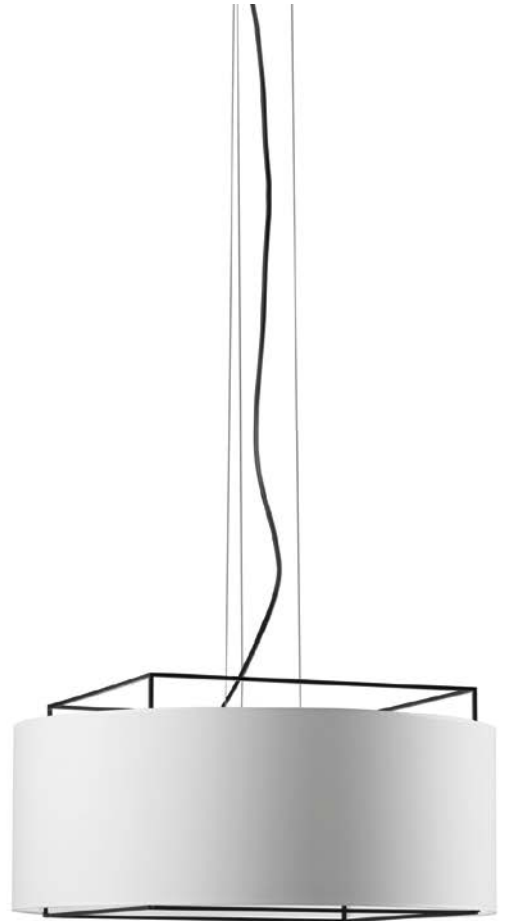

Hanging

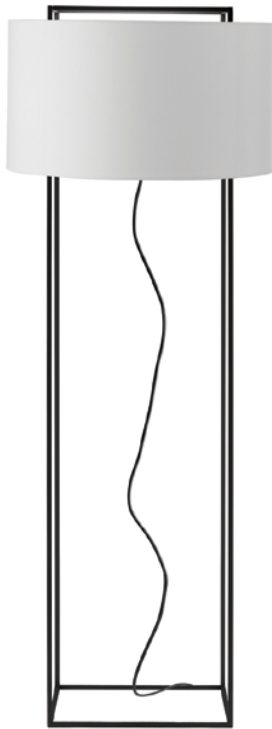
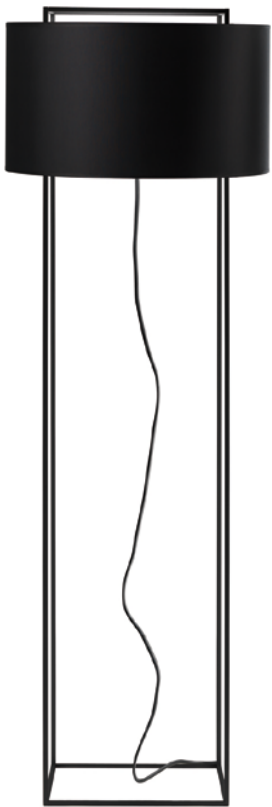

Wall

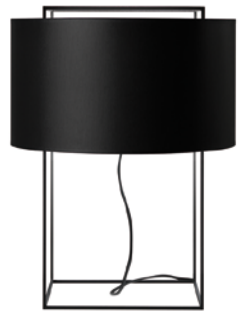
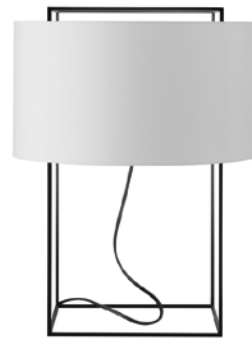
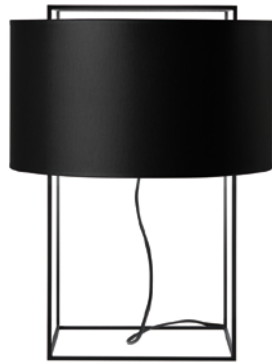

Floor

Table





Jordi Veciana (Barcelona, 1960) studied industrial design at the Elisava school in Barcelona and Parsons school in New York, where he worked for eleven years, first at Vignelli Associates and later at Polo Ralph Lauren, designing product, furniture, and store interiors. Back in Spain in 1998 he began to collaborate with Grupo Inditex as a creative director, conceiving of new concepts for the Zara Group's innovative retail spaces. Veciana entered into a partnership with the architect Jordi Castel in 2003, creating Castel Veciana Arquitectura. Shortly after he began his collaboration with Metalarte.



Hanging

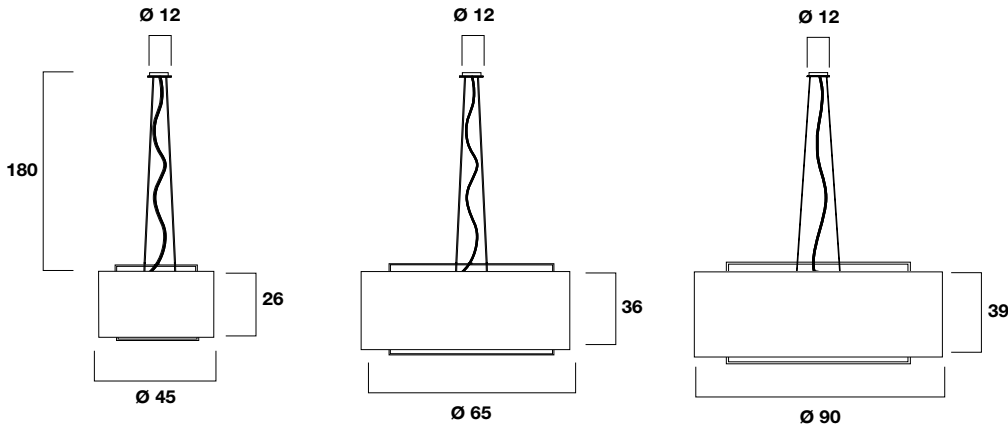

Floor

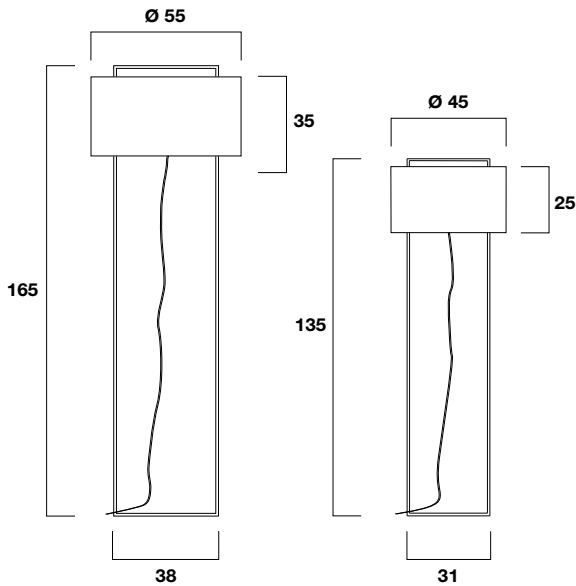

Table

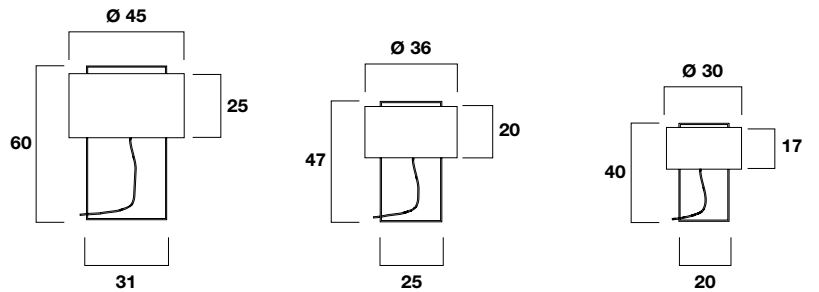

Wall

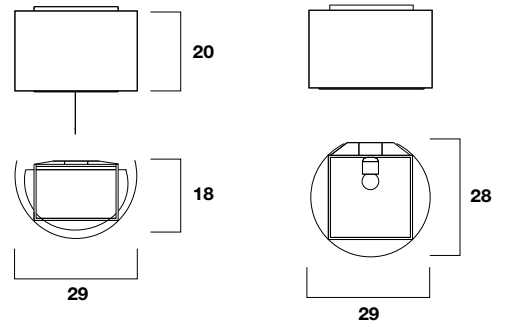

Ambient light luminaires. Cylindrical shade in black or white chintz fabric and new shades with Kvadrat fabrics: coral, grey, green. Opalux translucent lower diffuser for the hanging lamps versions and upper diffuser in perforated metal sheet for the table ones. Metal structure in 5 millimeters square bar, enamelled black or white.

Design Jordi Veciana

Measurements in cm.